

# SHELVING UNITS & CHECKOUT MERCHANDISERS

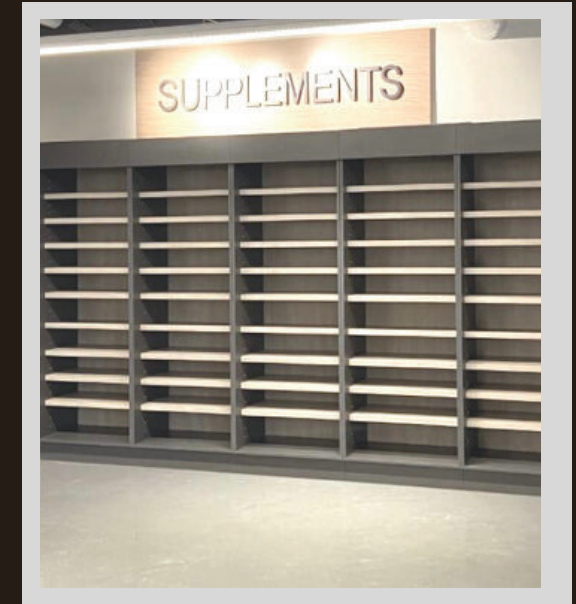

## QUALITY CONSTRUCTION

- Well built and versatile
- Display your products with confidence

- Choose either wood or laminate construction
- Maple, birch and oak are always in stock
- Ash and European beech are also available
- Stain or paint finish
- We offer a wide range of plastic laminate colours
- We are always happy to collaborate with you on custom fixtures



# M10 - MERCHANDISER

## M10 Features

- Designed to be placed along one side of the checkout conveyor belt
- Heavy duty casters - lockable & swiveling
- Slatwall reinforced with aluminum inserts
- Front shelves with 3 position tilt option
- Slatwall and 2 adjustable shelves on conveyor side
- Aisle side has 6 adjustable shelves

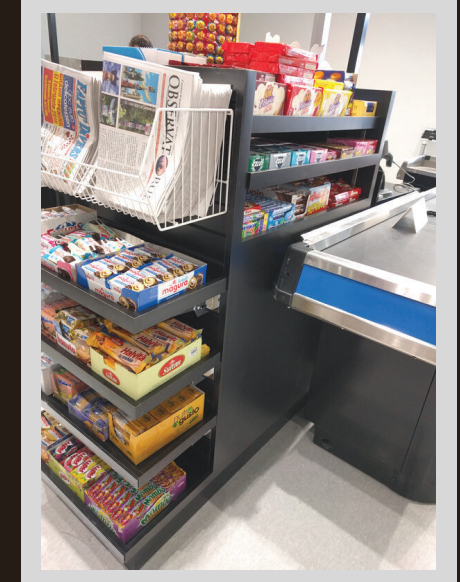

M10 - Checkout Display  
Lefthanded Version Shown

## Keep in mind...

- All dimensions shown are typical
- Custom sizing available to suit your needs
- All shelves have 1 1/2 high nosing
- Laminate/melamine (black) is our most popular finish.
- Wood and painted options are also available
- See "Colour & Inspiration" pages for more finish options

## Elevation and Section

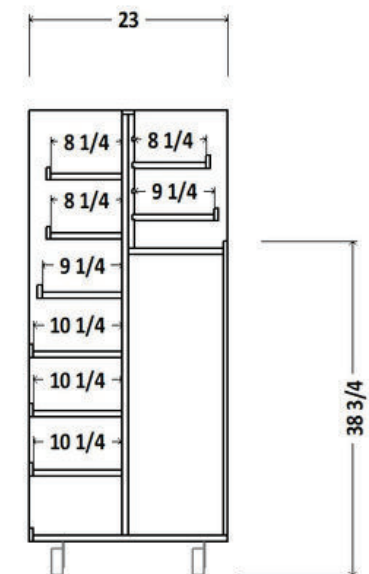
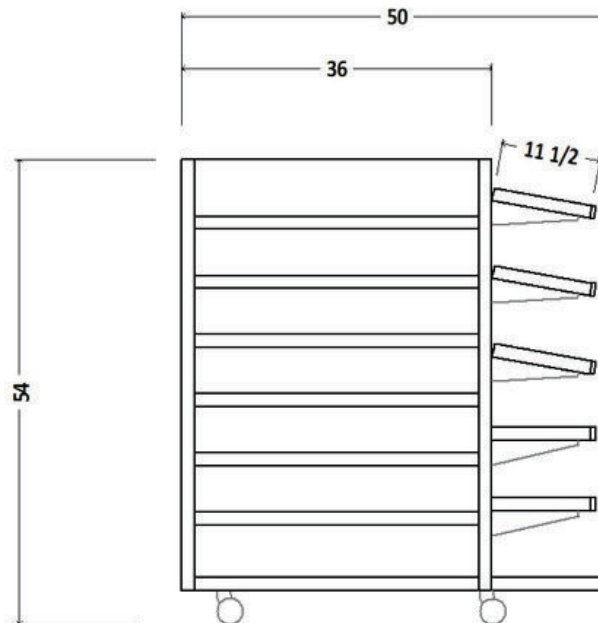

## M11 Features

- Designed to be placed in front of U-Shaped Checkouts
- Tiered front shelves on heavy duty brackets
- Side shelves on pilaster

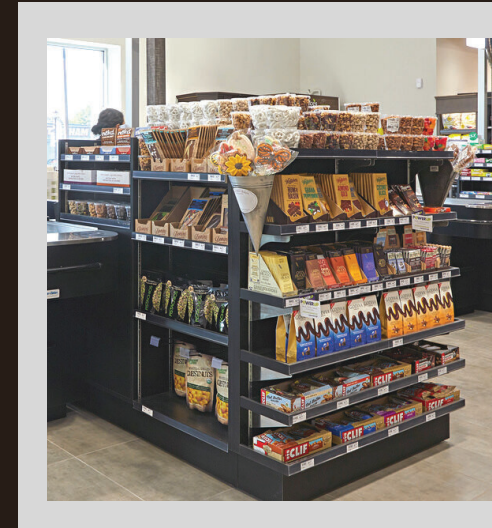
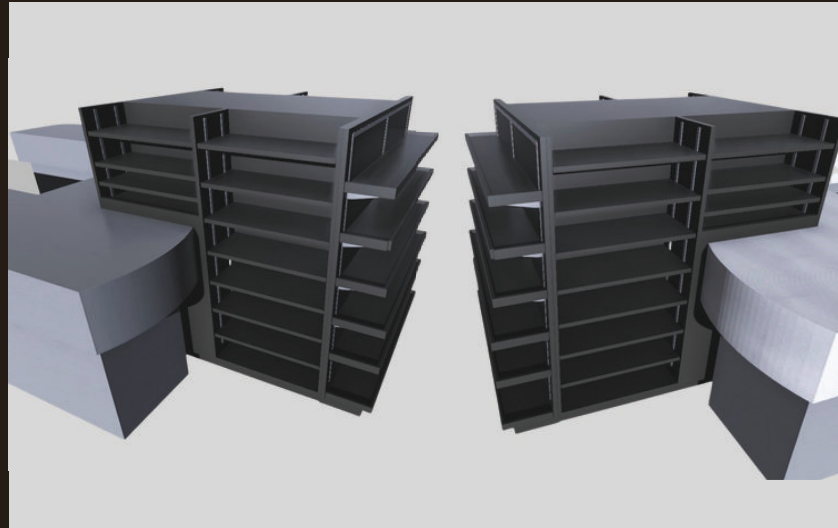

## M11 - Checkout Display

### Side and Front Elevation

### Keep in mind...

- All dimensions shown are typical
- Custom sizing available to suit your needs
- All shelves have 1 1/2" high nosing
- Laminate/melamine (black) is our most popular finish.
- Wood and painted options also available
- See "Colour & Inspiration" pages for more finish options

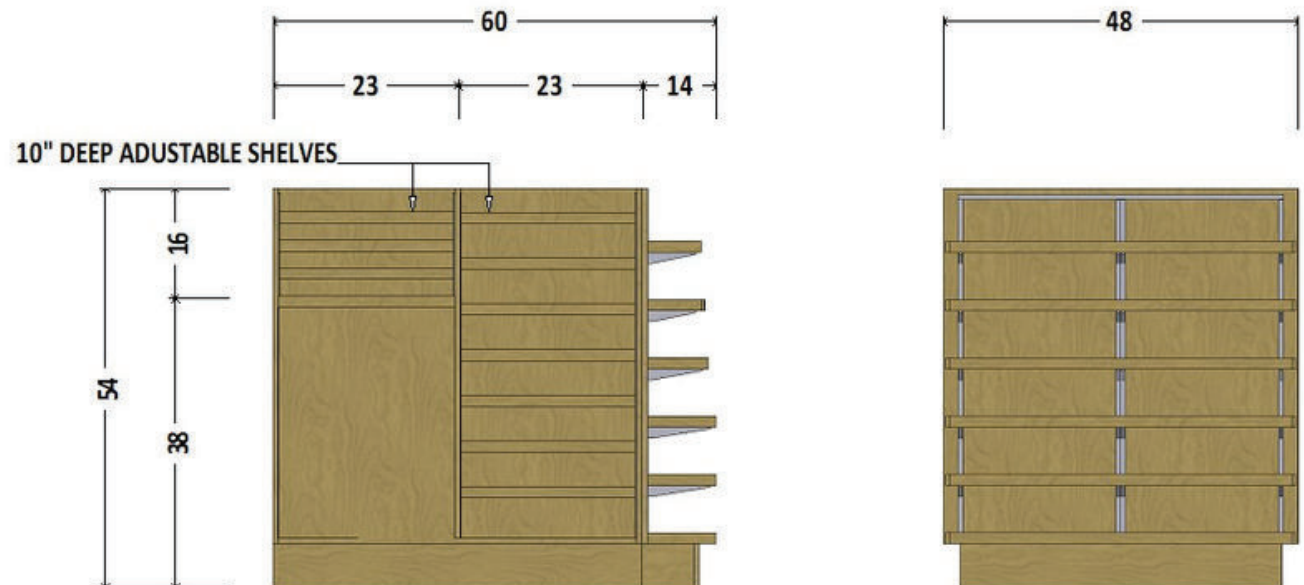

## S10 Features

- Suitable for heavier items
- Adjustable tiered shelving on heavy duty brackets
- Standard widths for Island sections are 36" or 48" wide
- Optional signholders shown
- Optional boston bumper
- Easy installation



S10 Double Sided Island Layout Example  
36" wide S10 Islands (x6), S11 End Caps (x2), Signholder Type A (x2)  
& Type B (x1)

## Keep in mind...

- All dimensions shown are typical
- Custom sizing available to suit your needs
- All shelves have 1 1/2 high nosing
- Laminate/melamine finish is standard
- Wood and painted options are also available
- Please confirm if using for wine or spirit display so we can inform you of width, shelf depth and layout perimeters
- See "Colour & Inspiration" pages for finish options

## Front Elevation & Section

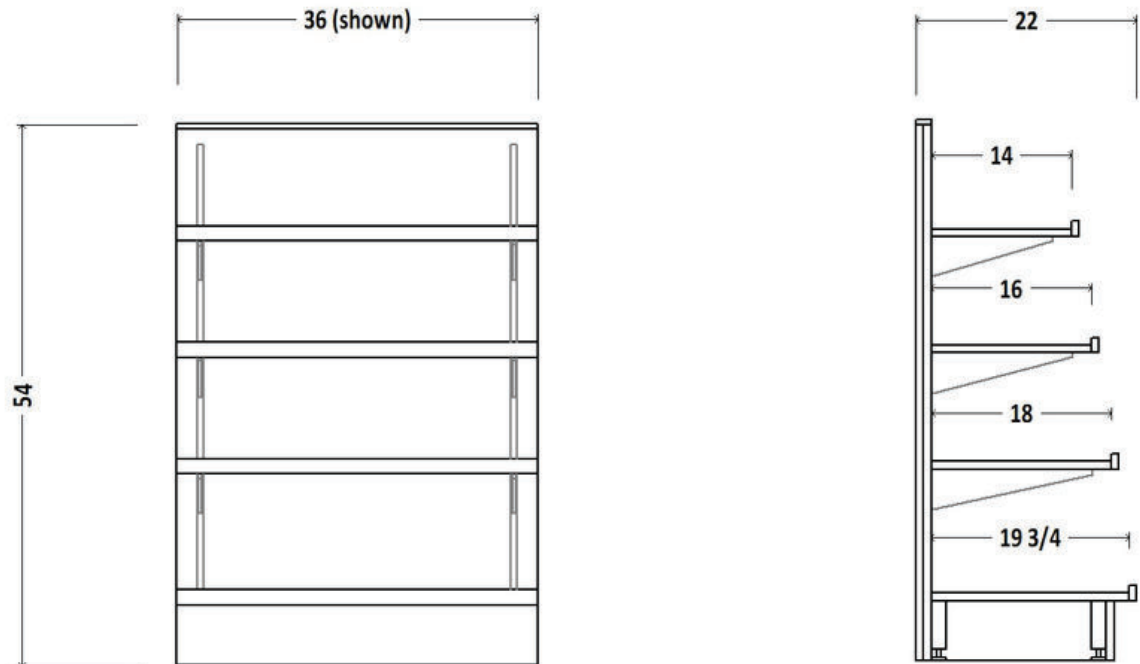

## S11- END CAP

### S11 Features

- Suitable for heavier items
- Adjustable tiered shelving on heavy duty brackets
- Optional signholder shown
- Optional boston bumper
- Can be used as a standalone unit
- Standalone unit has optional casters
- Easy installation



### S11 End Cap with Type A Signholder

#### Keep in mind...

- All dimensions shown are typical
- Custom sizing available to suit your needs
- All shelves have 1 1/2 high nosing
- Laminate/melamine finish is standard
- Wood and painted options are also available
- Please confirm if using for wine or spirit display so we can inform you of width, shelf depth and layout perimeters
- See "Colour & Inspiration" pages for finish options

#### Front Elevation & Section

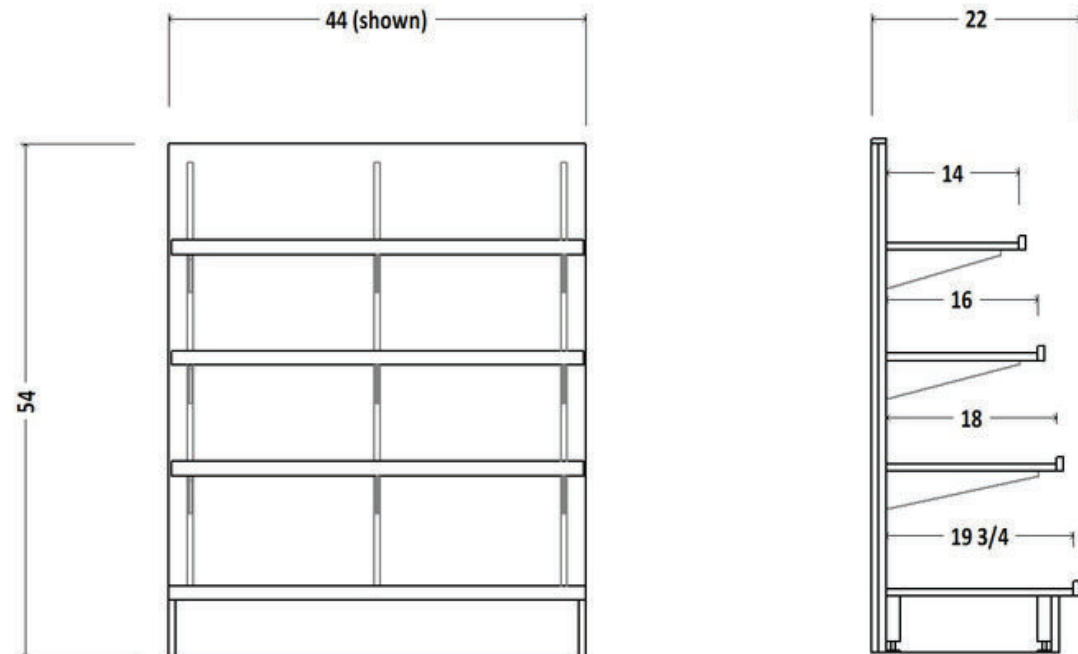

## S12 Features

- Suitable for heavier items
- Adjustable tiered shelving on heavy duty brackets
- Optional boston bumper shown
- Optional 6" signband header shown
- Easy installation

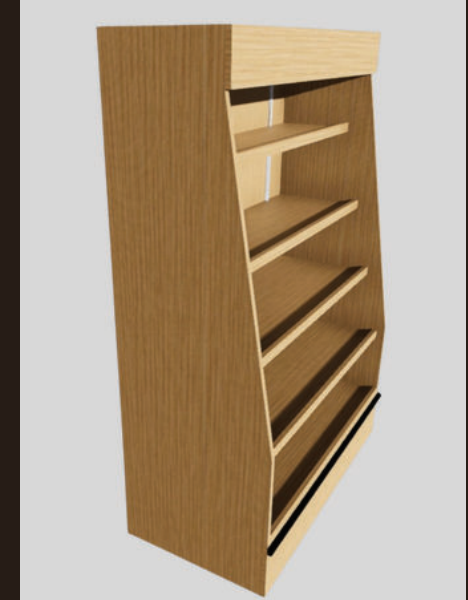

S12 Wall Shelving with Profiled Ends

## Keep in mind...

- All dimensions shown are typical
- Custom sizing available to suit your needs
- Secure to blocking in wall
- All shelves have 1 1/2 high nosing
- Laminate/melamine finish is standard
- Wood and painted options are also available
- Please confirm if using for wine or spirit display so we can inform you of width, shelf depth and layout perimeters
- See "Colour & Inspiration" pages for finish options

## Front Elevation & Section

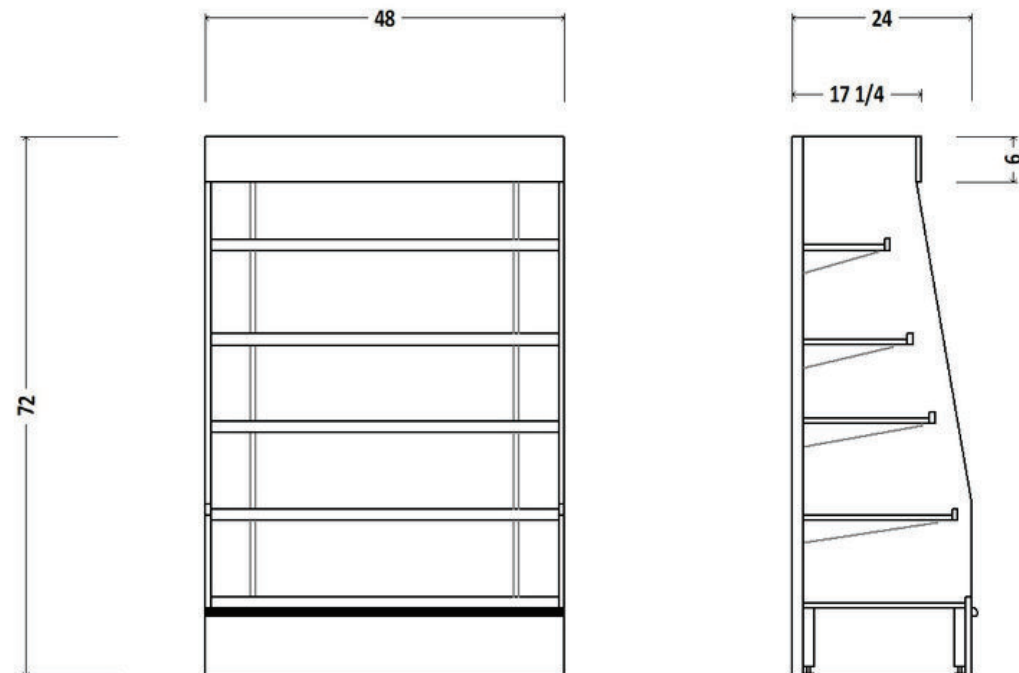

## WS10 Features

- Wall shelving designed for wine display
- Feature wine display shelf with sloped storage below and fixed shelves above
- 48" wide units with 9 equal sections shown
- Each section is wide enough to hold wine bottles up to a Magnum 1.5L
- If displaying 3L bottles please inform us as we will adjust the widths to accommodate
- Easy installation



WS10 Wine Shelf Unit



16ft Row - WS10 (x4)

## Keep in mind...

- All dimensions shown are typical
- Custom sizing available to suit your needs
- Secure to blocking in wall
- All shelves have 1 1/2" high nosing
- Wood fixture shown
- Laminate/melamine and painted options are also available
- See "Colour & Inspiration" pages for finish options

## Front Elevation & Section

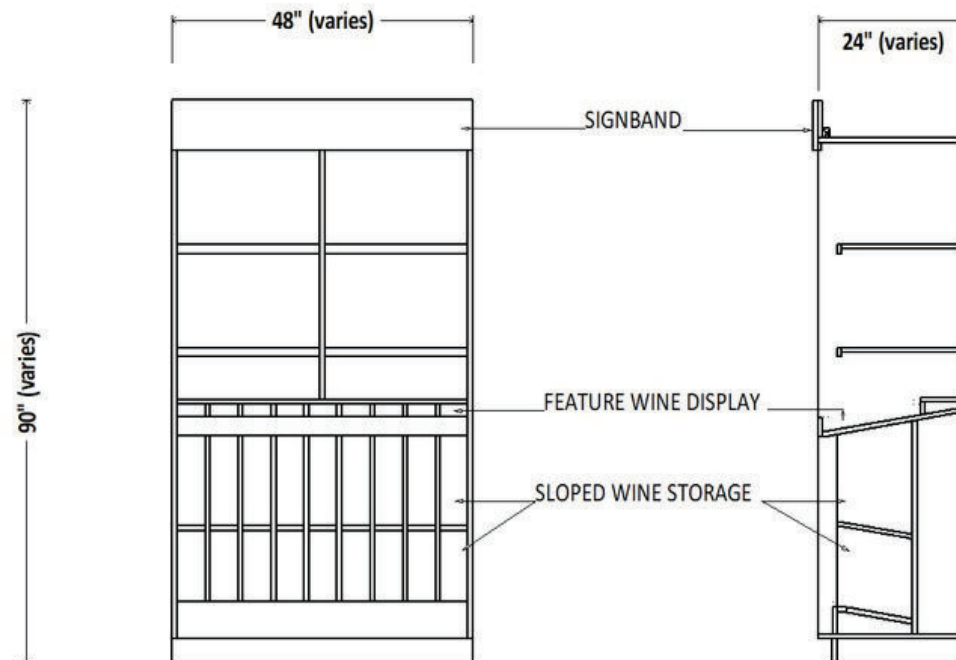

## WS11 Features

- Wall shelving designed to display wine & spirits
- Sturdy design allows for versatile uses
- Fixed Tiered Shelving
- Layout can be double-sided or freestanding
- Optional boston bumper shown
- Optional signage shown



Signholder Type A with Chalkboard option



## WS11 Double Sided Island Layout Example

WS11 Islands (x6), WS12 End Caps (x2), Signholder Type A (x2) & Type B (x1)

## Keep in mind...

- All dimensions shown are typical
- Custom sizing available to suit your needs
- 48" wide version shown
- All shelves have 1 1/2" high nosing
- Wood fixture shown
- Laminate/melamine and painted options are also available
- See "Colour & Inspiration" pages for finish options



## Front Elevation & Section

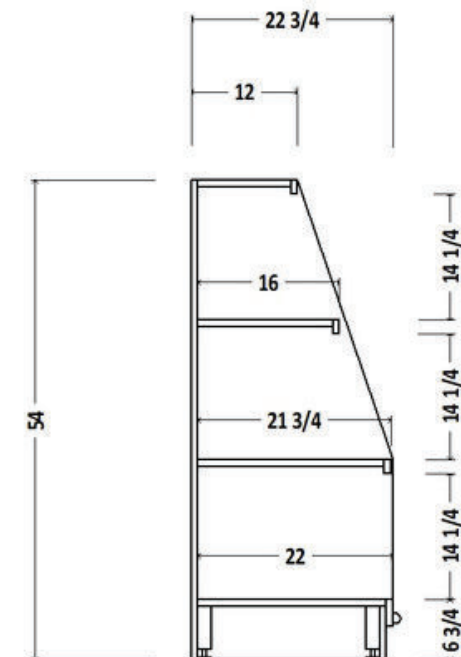

## WS12 Features

- End Cap designed to display wine & spirits
- Sturdy design allows for versatile uses
- Radius ends on all shelves
- Optional boston bumper shown
- Optional signage shown



Signholder Type A with Chalkboard option



WS12 End Cap

## Keep in mind...

- All dimensions shown are typical
- Custom sizing available to suit your needs
- 45 1/2" wide version required for standard double sided WS11 island
- All shelves have 1 1/2 high nosing
- Wood fixture shown
- Laminate/melamine and painted options are also available
- See "Colour & Inspiration" pages for finish options

## Front Elevation & Section

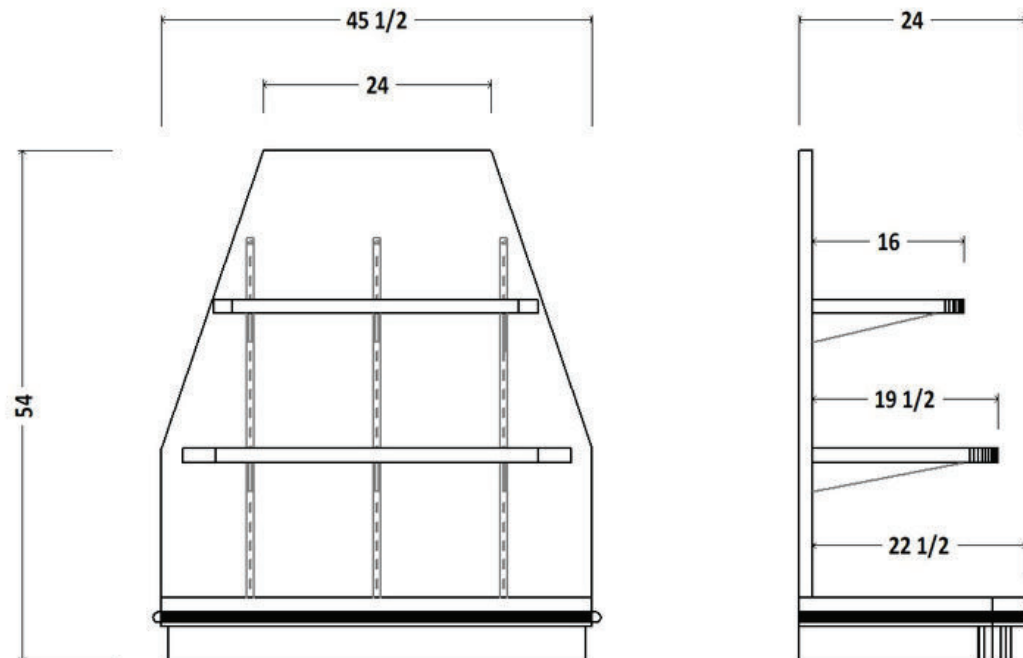

## S20 Features

- Wall shelving with adjustable shelves
- Adjustable shelves are on metal pins and ferrules
- Quantity of shelves is optional
- Middle shelf is fixed to ensure stability
- Optional signband header shown



S20 Wall Fixtures



S20 - 48" wide with drawers

## Keep in mind...

- All dimensions shown are typical
- Custom sizing available to suit your needs
- 36" wide version shown
- All shelves have 1 1/2" high nosing
- Standard finish is laminate/melamine
- Wood and painted options are also available
- See "Colour & Inspiration" pages for finish options

## Front Elevation & Section

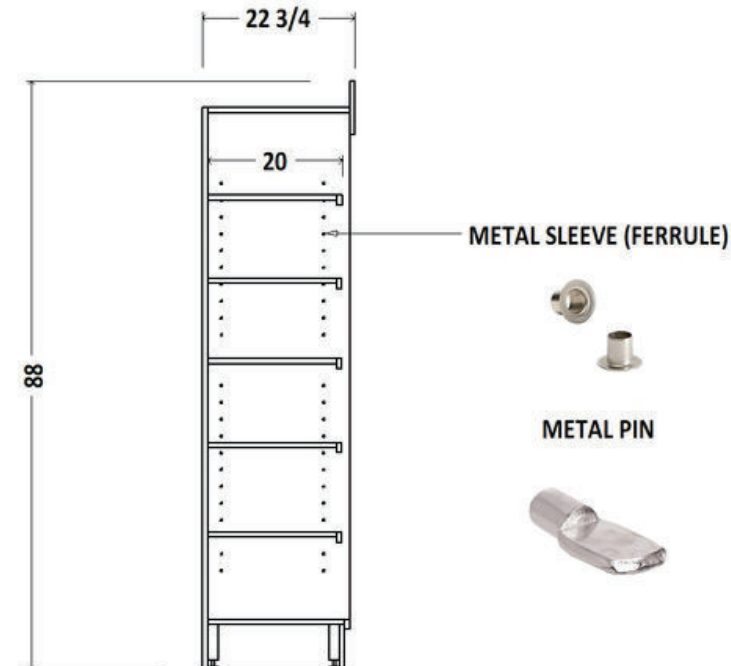

## S21 Features

- Island shelving with adjustable shelves
- Suitable for wall shelving
- Adjustable shelves on metal pins and ferrules
- Quantity of shelves is optional
- Example shown is a high gloss white
- Great fixture for the Beauty Department

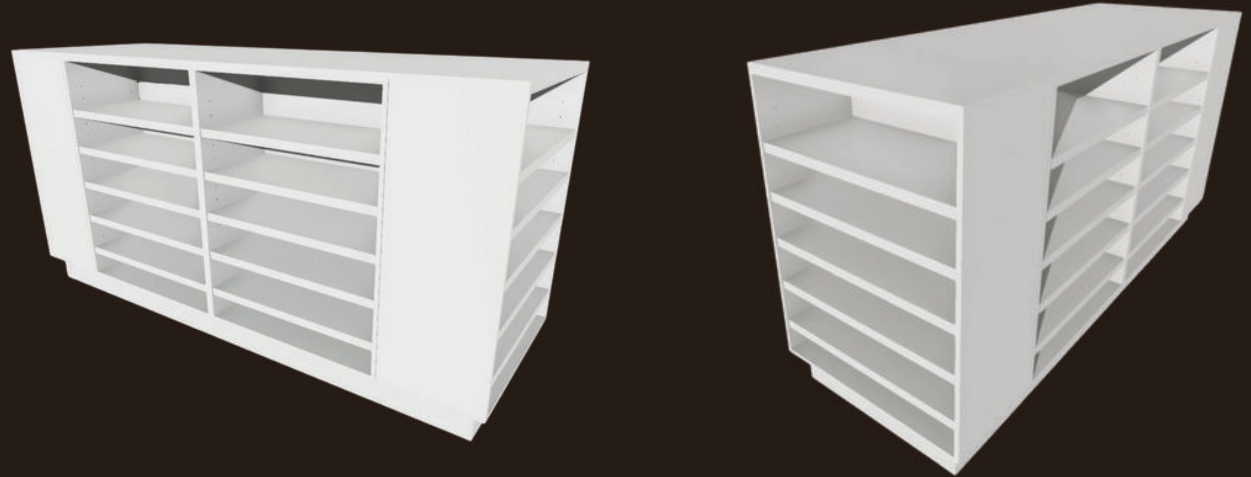

S21 Double Island Layout Example  
36" wide S20 (x6)

## Keep in mind...

- All dimensions shown are typical
- Custom sizing available to suit your needs
- 36" wide version shown
- All shelves have 1 1/2" high nosing
- 2-tone laminate/melamine version shown
- Wood and painted options are also available
- See "Colour & Inspiration" pages for finish options

## Front Elevation & Section

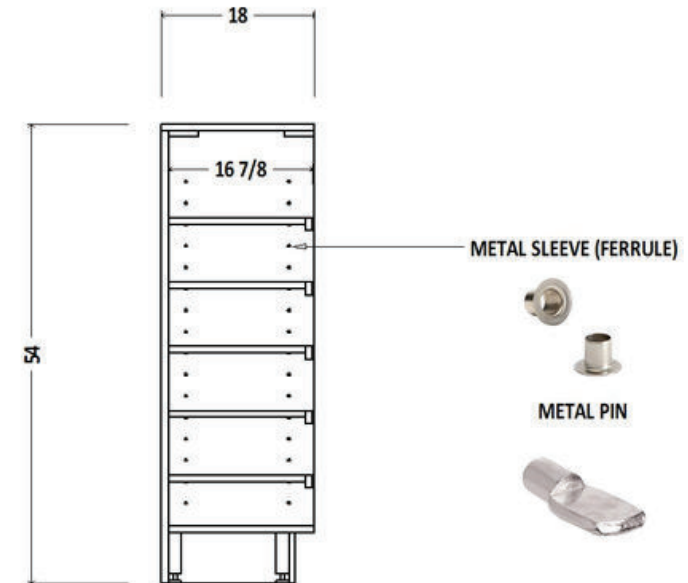

## Paint Finish



- All paint finishes are done in-house
- We apply 3 coats of tinted lacquer to achieve a durable and consistent finish
- Colour matching available



Wall shelving with a two tone distressed look at Summerhill Market

## Laminate/Melamine

- We deal with all of the major manufacturers including Formica, Wilsonart, Nevamar, & Uniboard
- Wide variety of colours and textures available



Corner Pastry Display in Black Laminate



Beauty Display in white laminate/melamine



## Wood Stains

- Samples shown on Birch & Maple

### Standard Colours

- Custom colour matching available

Steel Grey

Regency

Honey

Clear

Walnut

Cherry

